

# 2.5V Micropower SOT-23 Low Dropout Reference

March 2000

## FEATURES

- **High Accuracy:**
  - A Grade—0.05% Max
  - B Grade—0.1% Max
- **Low Drift:**
  - A Grade—10ppm/°C Max
  - B Grade—25ppm/°C Max
- Low Supply Current: 60µA Max
- Sinks and Sources: 5mA Min
- Low Dropout Voltage
- Guaranteed Operational –40°C to 125°C
- Wide Supply Range: 2.6V to 18V

## APPLICATIONS

- Handheld Instruments
- Negative Voltage References
- Industrial Control Systems
- Data Acquisition Systems
- Battery-Operated Equipment

## DESCRIPTION

The LT<sup>®</sup>1790-2.5 is a SOT-23 micropower low dropout series reference that combines high accuracy and low drift with low power dissipation and small package size. This micropower reference uses curvature compensation to obtain a low temperature coefficient and trimmed precision thin-film resistors to achieve high output accuracy. In addition, the LT1790-2.5 uses post-package trimming to greatly reduce the temperature coefficient and increase the output accuracy. Output accuracy is further assured by excellent line and load regulation. Special care has been taken to minimize thermally induced hysteresis.

The LT1790-2.5 is ideally suited for battery-operated systems because of its small size, low supply current and reduced dropout voltage. This reference provides supply current and power dissipation advantages over shunt references that must idle the entire load current to operate. However, since the LT1790-2.5 can also sink current, it can operate as a micropower negative voltage reference with the same performance as a positive reference.

LT, LTC and LT are registered trademarks of Linear Technology Corporation.

## TYPICAL APPLICATION

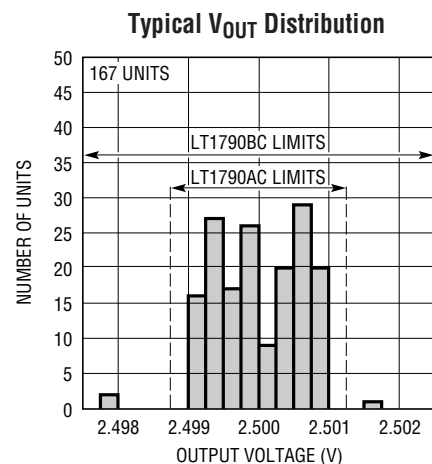
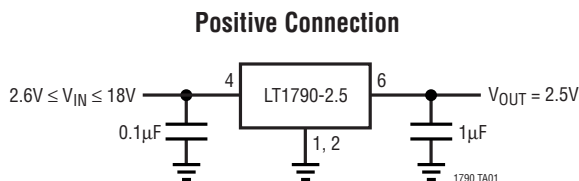

1790 TA02

**ABSOLUTE MAXIMUM RATINGS**

(Note 1)

Input Voltage .....	20V
Specified Temperature Range .....	0°C to 70°C
Operating Temperature Range	
(Note 2) .....	-40°C to 125°C
Storage Temperature Range	
(Note 3) .....	-65°C to 150°C
Lead Temperature (Soldering, 10 sec) .....	300°C

**PACKAGE/ORDER INFORMATION**

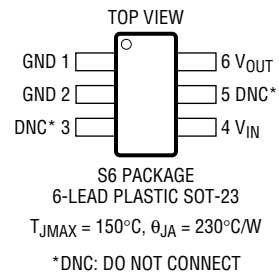
	ORDER PART NUMBER
	LT1790ACS6-2.5 LT1790BCS6-2.5
	S6 PART MARKING
	LTMX LTMZ

Consult factory for Industrial and Military grade parts.

**ELECTRICAL CHARACTERISTICS** The ● denotes specifications that apply over the specified temperature range, otherwise specifications are at  $T_A = 25^\circ\text{C}$ .  $V_{IN} = 3\text{V}$ ,  $C_L = 1\mu\text{F}$  unless otherwise specified.

PARAMETER	CONDITIONS	MIN	TYP	MAX	UNITS	
Output Voltage (Notes 3, 4)	LT1790ACS6-2.5	2.49875 -0.05	2.50	2.50125 0.05	V %	
	LT1790BCS6-2.5	2.4975 -0.1	2.50	2.5025 0.1	V %	
Output Voltage Temperature Coefficient (Note 5)	LT1790ACS6-2.5	●	5	10	ppm/°C	
	LT1790BCS6-2.5	●	12	25	ppm/°C	
Line Regulation	$3\text{V} \leq V_{IN} \leq 18\text{V}$	●	50	170	ppm/V	
				220	ppm/V	
Load Regulation (Note 6)	$I_{OUT}$ Source = 5mA $I_{OUT}$ Sink = 5mA	●	80	160	ppm/mA	
				250	ppm/mA	
			70	110	ppm/mA	
Dropout Voltage (Note 7)	$V_{IN} - V_{OUT}$ , $\Delta V_{OUT} \leq 0.1\%$ $I_{OUT} = 0\text{mA}$ $I_{OUT}$ Source = 5mA $I_{OUT}$ Sink = 5mA	●	60	100	mV	
			●	300	400	mV
			●	40	250	mV
			●			
Supply Current	$V_{OUT} = 2.5\text{V}$	●	35	60 75	$\mu\text{A}$ $\mu\text{A}$	
Minimum Current	$V_{OUT} = -2.5\text{V}$		100	125	$\mu\text{A}$	
Turn-On Time	$C_{LOAD} = 1\mu\text{F}$		700		$\mu\text{s}$	
Output Noise (Note 8)	0.1Hz $\leq$ f $\leq$ 10Hz 10Hz $\leq$ f $\leq$ 1kHz		12		$\mu\text{V}_{P-P}$	
			33		$\mu\text{V}_{RMS}$	
Long-Term Drift of Output Voltage (Note 9)			50		ppm/ $\sqrt{\text{kHr}}$	
Hysteresis (Note 10)	$\Delta T = 0^\circ\text{C}$ to $70^\circ\text{C}$ $\Delta T = -40^\circ\text{C}$ to $85^\circ\text{C}$	●	40		ppm	
			●	60		ppm

**Note 1:** Absolute Maximum Ratings are those values beyond which the life of the device may be impaired.

**Note 2:** The LT1790S6 is guaranteed functional over the operating temperature range of  $-40^\circ\text{C}$  to  $125^\circ\text{C}$ .

**Note 3:** If the part is stored outside of the specified temperature range, the output voltage may shift due to hysteresis.

**Note 4:** ESD (Electrostatic Discharge) sensitive device. Extensive use of ESD protection devices are used internal to the LT1790, however, high electrostatic discharge can damage or degrade the device. Use proper ESD handling precautions.

## ELECTRICAL CHARACTERISTICS

**Note 5:** Temperature coefficient is measured by dividing the change in output voltage by the specified temperature range. Incremental slope is also measured at 25°C.

**Note 6:** Load regulation is measured on a pulse basis from no load to the specified load current. Output changes due to die temperature change must be taken into account separately.

**Note 7:** Excludes load regulation errors.

**Note 8:** Peak-to-peak noise is measured with a single pole highpass filter at 0.1Hz and a 2-pole lowpass filter at 10Hz. The unit is enclosed in a still air environment to eliminate thermocouple effects on the leads. The test time is 10 seconds. RMS noise is measured with a single pole highpass filter at 10Hz and a 2-pole lowpass filter at 1kHz. The resulting output is full-wave rectified and then integrated for a fixed period, making the final reading an average as opposed to RMS. A correction factor of 1.1 is used to convert from average to RMS and a second correction of 0.88 is used to correct for the nonideal bandpass of the filters.

**Note 9:** Long-term drift typically has a logarithmic characteristic and therefore changes after 1000 hours tend to be smaller than before that time. Total drift in the second thousand hours is normally less than one third that to the first thousand hours with a continuing trend toward reduced drift with time. Long-term drift is affected by differential stress between the IC and the board material created during board assembly. See Applications Information.

**Note 10:** Hysteresis in the output voltage is created by package stress that differs depending on whether the IC was previously at a higher or lower temperature. Output voltage is always measured at 25°C, but the IC is cycled to 85°C or -40°C before a successive measurements. Hysteresis is roughly proportional to the square of the temperature change. Hysteresis is not normally a problem for operational temperature excursions where the instrument might be stored at high or low temperature. See Applications Information.

## TYPICAL PERFORMANCE CHARACTERISTICS

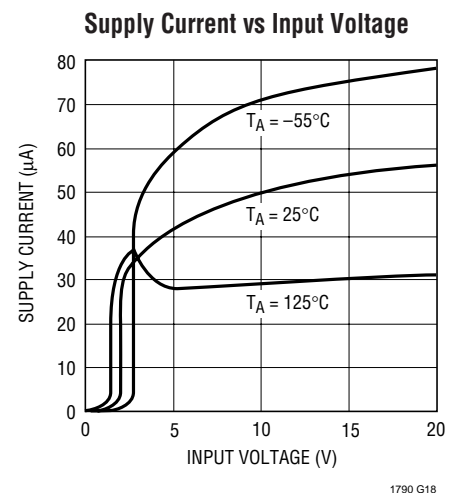
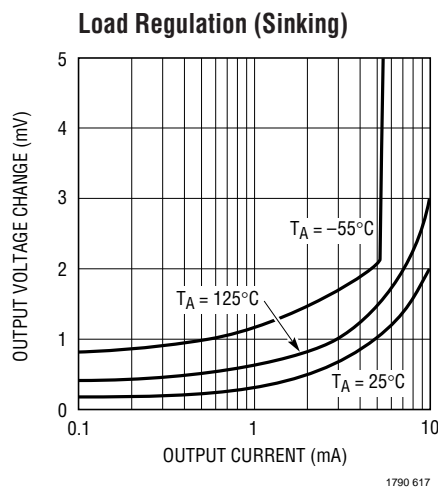
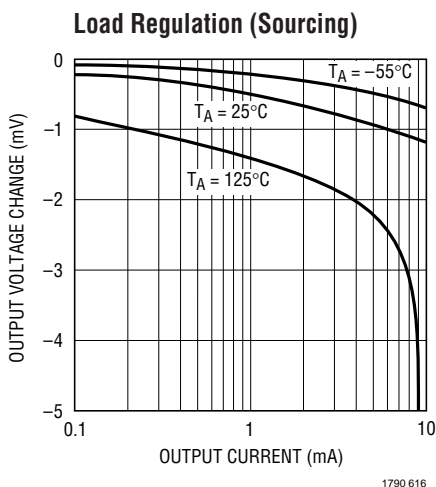
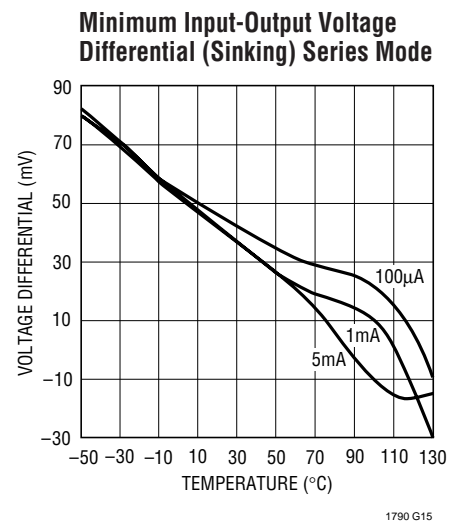
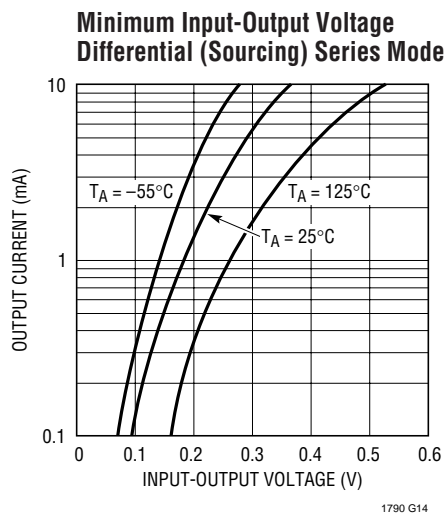
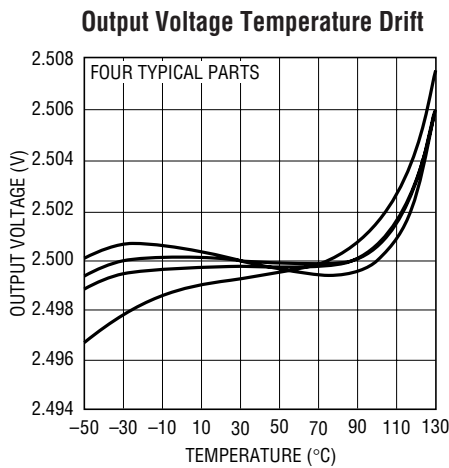

# TYPICAL PERFORMANCE CHARACTERISTICS

**Line Regulation**

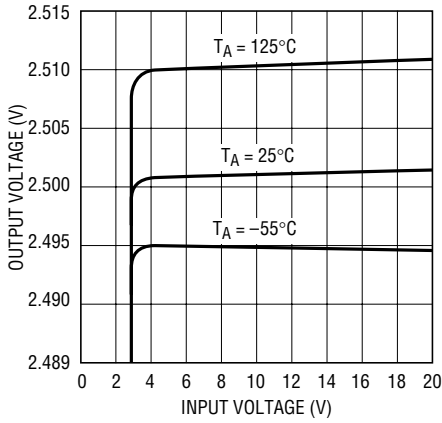

1790 G19

**Power Supply Rejection Ratio vs Frequency**

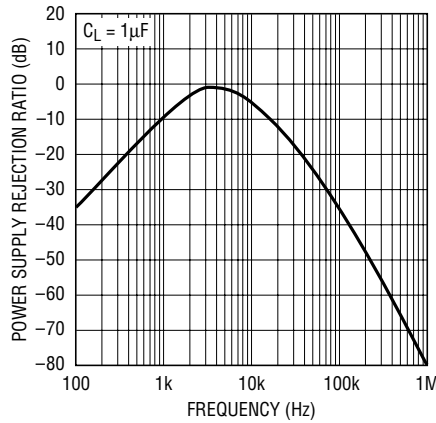

1790 G20

**Output Impedance vs Frequency**

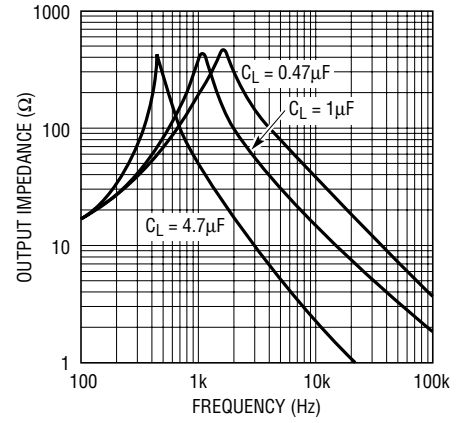

1790 G21

**-2.5V Characteristics**

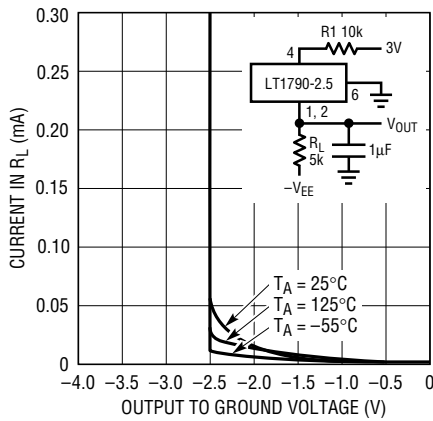

1790 G22

**Long-Term Drift (Data Points Reduced After 500 Hr)**

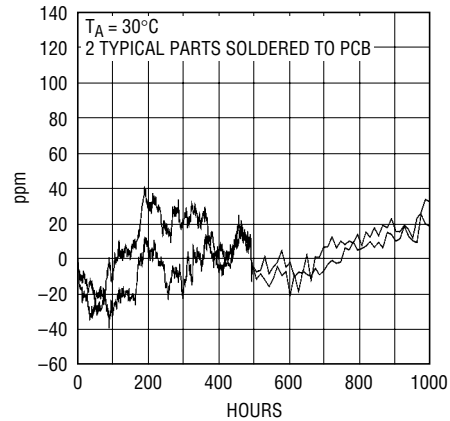

1790 G23

**Output Noise 0.1Hz to 10Hz**

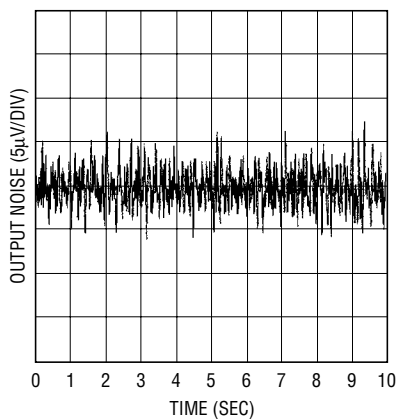

1790 G24

**Output Voltage Noise Spectrum**

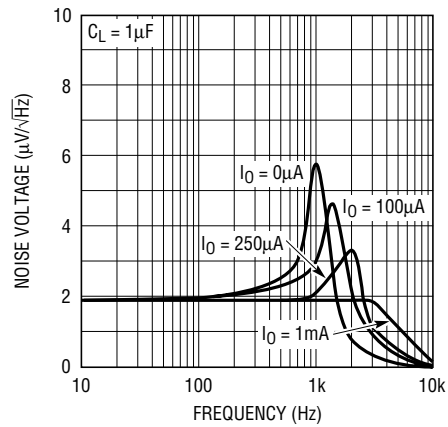

1790 G25

## APPLICATIONS INFORMATION

### Bypass and Load Capacitors

The LT1790-2.5 voltage reference should have an input bypass capacitor of 0.1 $\mu$ F or larger, however the bypassing of other local devices may serve as the required component. This reference also requires an output capacitor for stability. The optimum output capacitance for most applications is 1 $\mu$ F, although larger values work as well. This capacitor affects the turn-on and settling time for the output to reach its final value.

Figure 1 shows the turn-on time for the LT1790-2.5 with a 1 $\mu$ F input bypass and 1 $\mu$ F load capacitor. Figure 2 shows the output response to a 0.5V transient on  $V_{IN}$  with the same capacitors.

The test circuit of Figure 3 is used to measure the stability of various load currents. With  $R_L = 1k$ , the 1V step produces a current step of 1mA. Figure 4 shows the response to a  $\pm 0.5mA$  load. Figure 5 is the output response to a sourcing step from 4mA to 5mA, and Figure 6 is the output response of a sinking step from  $-4mA$  to  $-5mA$ .

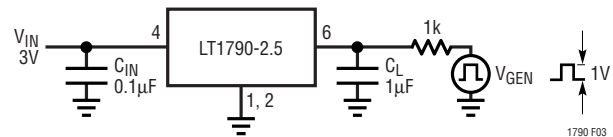

Figure 3. Response Time Test Circuit

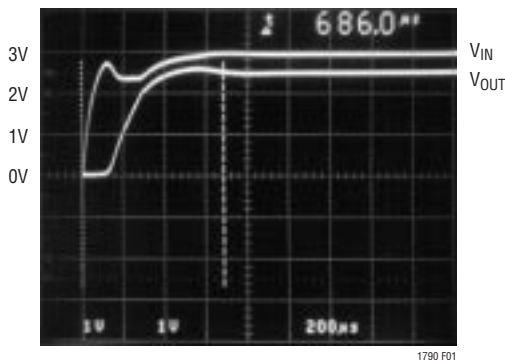

Figure 1. Turn-On Characteristics of LT1790-2.5

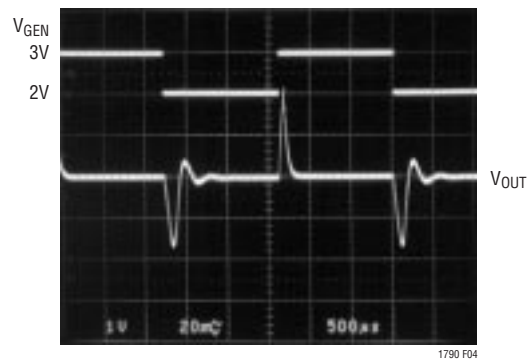

Figure 4. LT1790-2.5 Sourcing and Sinking 0.5mA

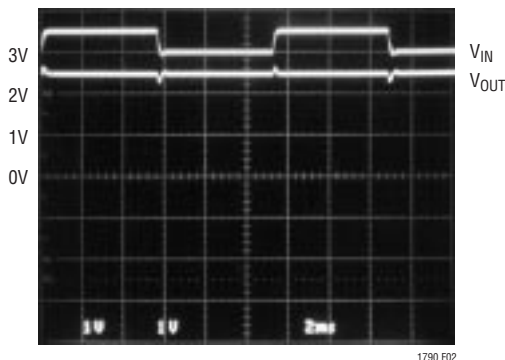

Figure 2. Output Response to 0.5V Ripple on  $V_{IN}$

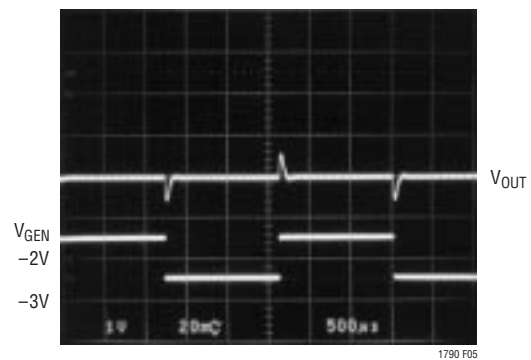

Figure 5. LT1790-2.5 Sourcing 4mA to 5mA

## APPLICATIONS INFORMATION

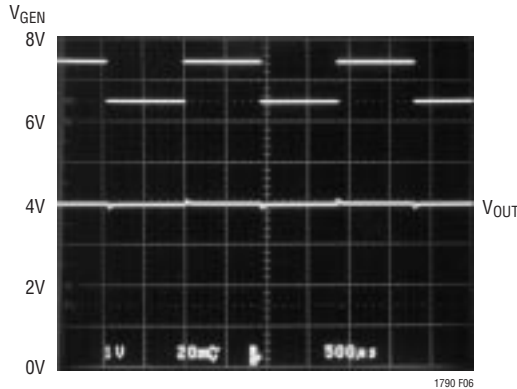

Figure 6. LT1790-2.5 Sinking –4mA to –5mA

### Positive or Negative Operation

Series operation is ideal for extending battery life. If the LT1790-2.5 is operated in series mode it does not require an external current setting resistor. The specifications guarantee the LT1790-2.5 operates from 2.6V to 18V. When the circuitry being regulated does not demand current, the series connected LT1790-2.5 consumes only a few hundred  $\mu\text{W}$ , yet the same connection can sink or source 5mA of load current when demanded. A typical series connection is shown on the front page of this data sheet.

The circuit in Figure 7 shows the connection for a –2.5V reference. The LT1790-2.5 can be used as a very stable negative reference, however, it requires a positive voltage applied to Pin 4 to bias internal circuitry. This voltage must be current limited with R1 to keep the output PNP

transistor from turning on and driving the grounded output. C1 provides stability during load transients. This connection maintains the accuracy and temperature coefficient of the positive connected LT1790-2.5.

### Long-Term Drift

**Long-term drift cannot be extrapolated from accelerated high temperature testing. This erroneous technique gives drift numbers that are widely optimistic. The only way long-term drift can be determined is to measure it over the time interval of interest.** The LT1790S6 drift data was taken on over 100 parts that were soldered into PC boards similar to a “real world” application. The boards were then placed into a constant temperature oven with  $T_A = 30^\circ\text{C}$ , their outputs scanned regularly and measured with an 8.5 digit DVM. Long-term drift curves are shown in the Typical Performance Characteristics.

### Hysteresis

Hysteresis data shown in Figures 8 and 9 represent the worst-case data taken on parts from  $0^\circ\text{C}$  to  $70^\circ\text{C}$  and from  $-40^\circ\text{C}$  to  $85^\circ\text{C}$ . Units were cycled several times over these temperature ranges and the largest change is shown. As expected, the parts cycled over the higher temperature range have higher hysteresis than those cycled over the lower range.

When the LT1790-2.5 is IR reflow soldered onto a PC board, the output shift is typically just 150ppm (0.015%).

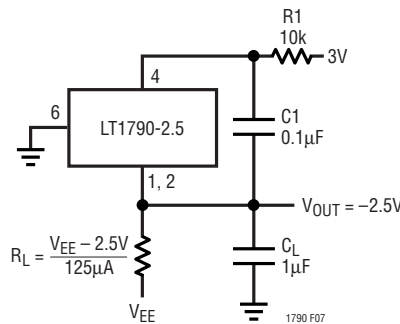

Figure 7. Using the LT1790-2.5 to Build a –2.5V Reference

## APPLICATIONS INFORMATION

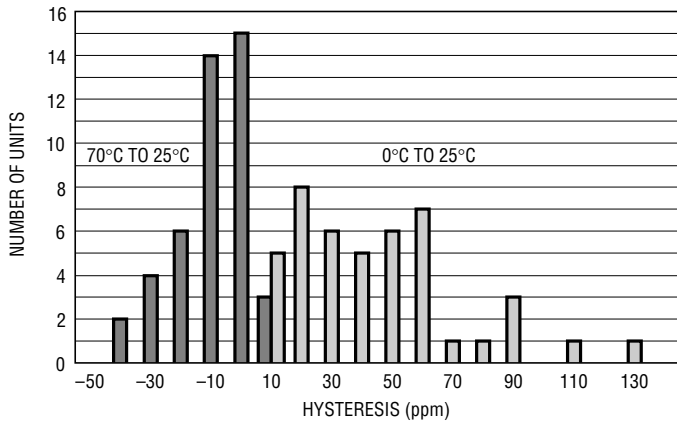

Figure 8. Worst-Case 0°C to 70°C Hysteresis on 44 Units

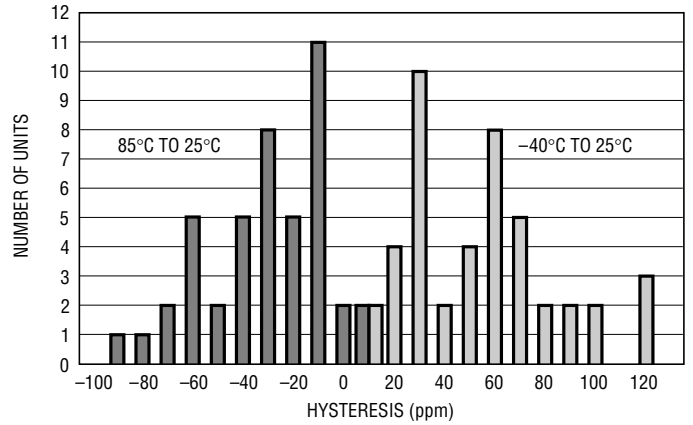
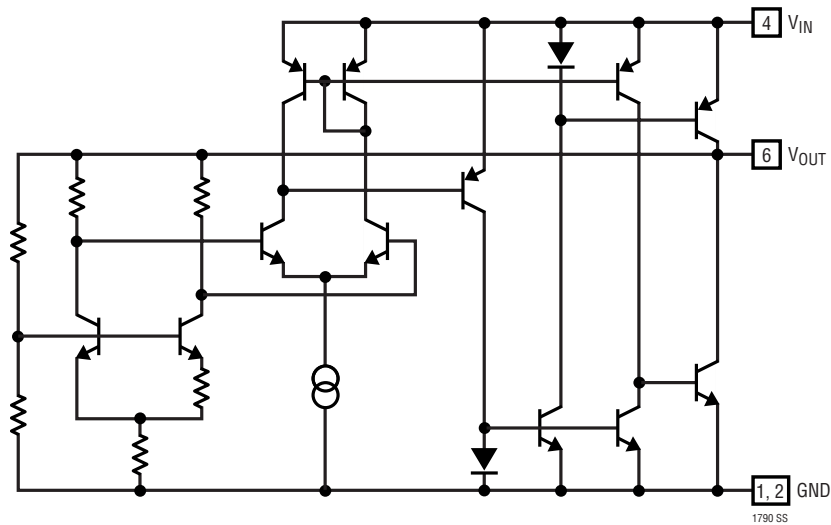

Figure 9. Worst-Case -40°C to 85°C Hysteresis on 44 Units

## SIMPLIFIED SCHEMATIC



**TYPICAL APPLICATION**

**-2.5V Negative 50mA Series Reference  
No Load Supply Current**

$I_{CC} = 1.6\text{mA}$

$I_{EE} = 440\mu\text{A}$

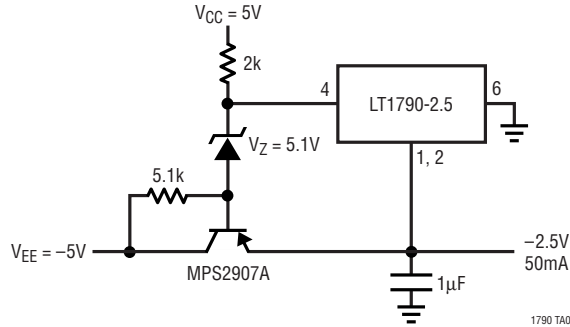

**PACKAGE DESCRIPTION**

Dimensions in inches (millimeters) unless otherwise noted.

**S6 Package  
6-Lead Plastic SOT-23  
(LTC DWG # 05-08-1634)**

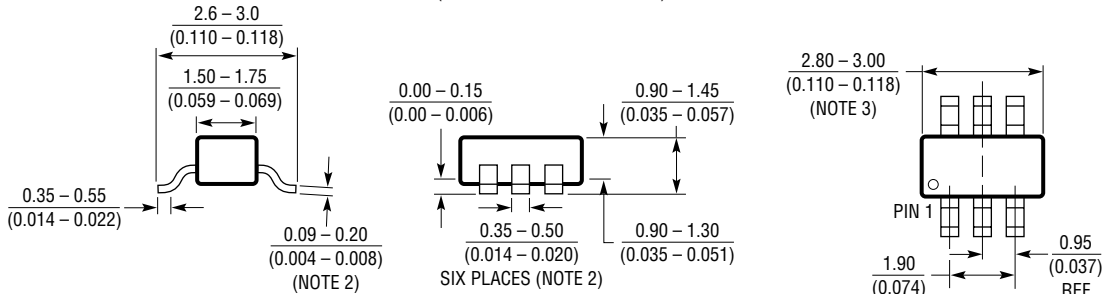

- NOTE:
1. DIMENSIONS ARE IN MILLIMETERS
  2. DIMENSIONS ARE INCLUSIVE OF PLATING
  3. DIMENSIONS ARE EXCLUSIVE OF MOLD FLASH AND METAL BURR
  4. MOLD FLASH SHALL NOT EXCEED 0.254mm
  5. PACKAGE EIAJ REFERENCE IS SC-74A (EIAJ)

**RELATED PARTS**

PART NUMBER	DESCRIPTION	COMMENTS
LT1019	Precision Reference	Bandgap, 0.05%, 5ppm/°C
LT1027	Precision 5V Reference	Lowest TC, High Accuracy, Low Noise, Zener Based
LT1236	Precision Reference	5V and 10V Zener-Based 5ppm/°C, SO-8 Package
LTC®1798	Micropower Low Dropout Reference	0.15% Max, 6.5µA Supply Current
LT1460	Micropower Precision Series Reference	Bandgap, 130µA Supply Current, 10ppm/°C, Available in SOT-23
LT1461	Micropower Precision Low Dropout Reference	Bandgap 0.04%, 3ppm/°C, 50µA Max Supply Current
LT1634	Micropower Precision Shunt Voltage Reference	Bandgap, 0.05%, 10ppm/°C, 10µA Supply Current